

**SF2321D**

**1090 MHz  
SAW Filter**

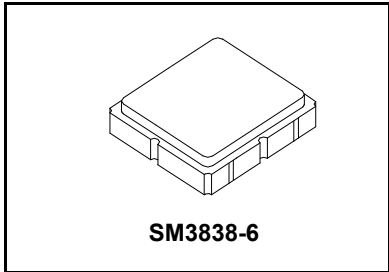

- **Low-loss SAW Filter**
- **No Matching Required for 50 ohm Source/Load**
- **3.8 x 3.8 x 1.4 mm Surface-mount Package**
- **Complies with Directive 2002/95/EC (RoHS)**



**Absolute Maximum Ratings**

Rating	Value	Units
Maximum Incident Power in Passband	+20	dBm
Maximum DC Voltage on any Non-ground Terminals	3	VDC
Operating Temperature Range	-40 to +85	°C
Storage Temperature Range in Tape and Reel	-55 to +85	°C
Suitable for Lead-free Soldering - Maximum Soldering Profile	260°C for 30 s	

**Electrical Characteristics**

Characteristic	Sym	Notes	Min	Typ	Max	Units
Center Frequency	$f_c$	1		1090		MHz
Insertion Loss, 1075 to 1105 MHz	IL			2.4	3.0	dB
Amplitude Ripple, 1085 to 1095 MHz				0.1	1.0	dB <sub>P-P</sub>
VSWR, 1075 to 1105 MHz				1.8:1	2.1:1	
Rejection Referenced to 0 dB:		1, 2, 3				dB
DC to 970 MHz			25	30		
1150 to 1300 MHz			25	33.5		
Single-ended Source Impedance	50 ohm					
Single-ended Load Impedance	50 ohm					

Case Style	SM3838-6 3.8 x 3.8 mm Nominal Footprint					
Lid Symbolization (Y=year, WW=week, S=shift) dot=pin 1 indicator	A81, YWWS					
Standard Reel Quantity	Reel Size 7 Inch					500 Pieces/Reel
	Reel Size 13 Inch					3000 Pieces/Reel

**Electrical Connections**

Connection	Terminals
Port 1	2
Port 2	5
Case Ground	All others



**CAUTION: Electrostatic Sensitive Device. Observe precautions for handling.**

**NOTES:**

1. Unless noted otherwise, all specifications apply over the operating temperature range with filter soldered to the specified demonstration board with impedance matching to 50 Ω and measured with 50 Ω network analyzer.
2. Unless noted otherwise, all frequency specifications are referenced to the nominal center frequency,  $f_c$ .
3. Rejection is measured as attenuation below the minimum IL point in the passband. Rejection in final user application is dependent on PCB layout and external impedance matching design. See Application Note No. 42 for details.
4. "LRIP" or "L" after the part number indicates "low rate initial production" and "ENG" or "E" indicates "engineering prototypes."
5. The design, manufacturing process, and specifications of this filter are subject to change.
6. Either Port 1 or Port 2 may be used for either input or output in the design. However, impedances and impedance matching may vary between Port 1 and Port 2, so that the filter must always be installed in one direction per the circuit design.
7. US and international patents may apply.
8. Murata, stylized Murata logo, and Murata N.A., Inc. are registered trademarks of Murata Manufacturing Co., Ltd.

# Frequency Characteristics

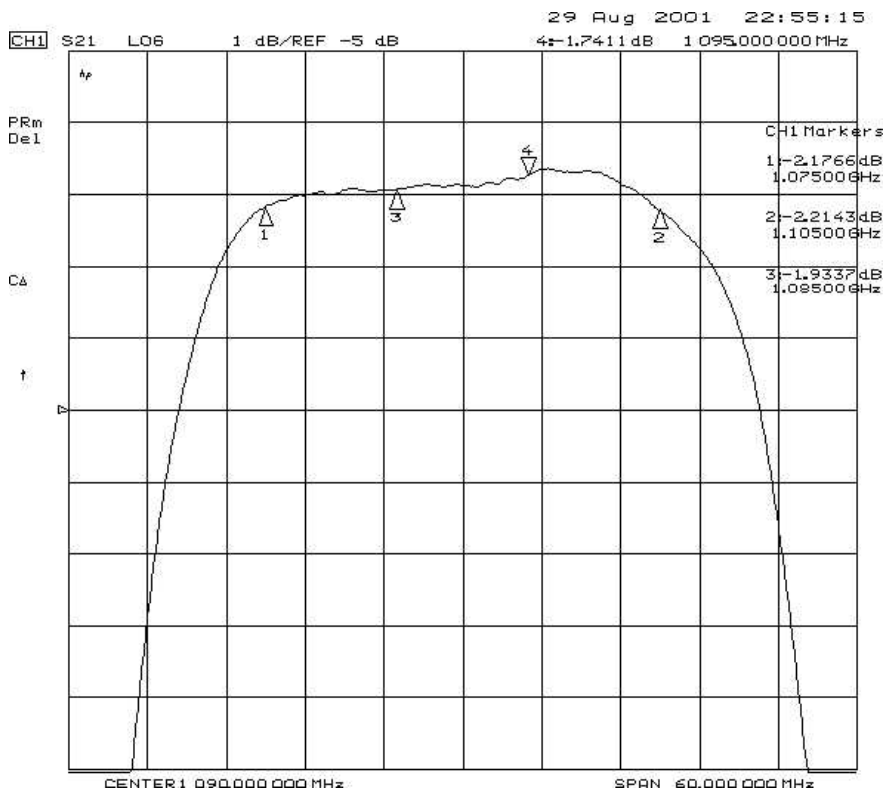
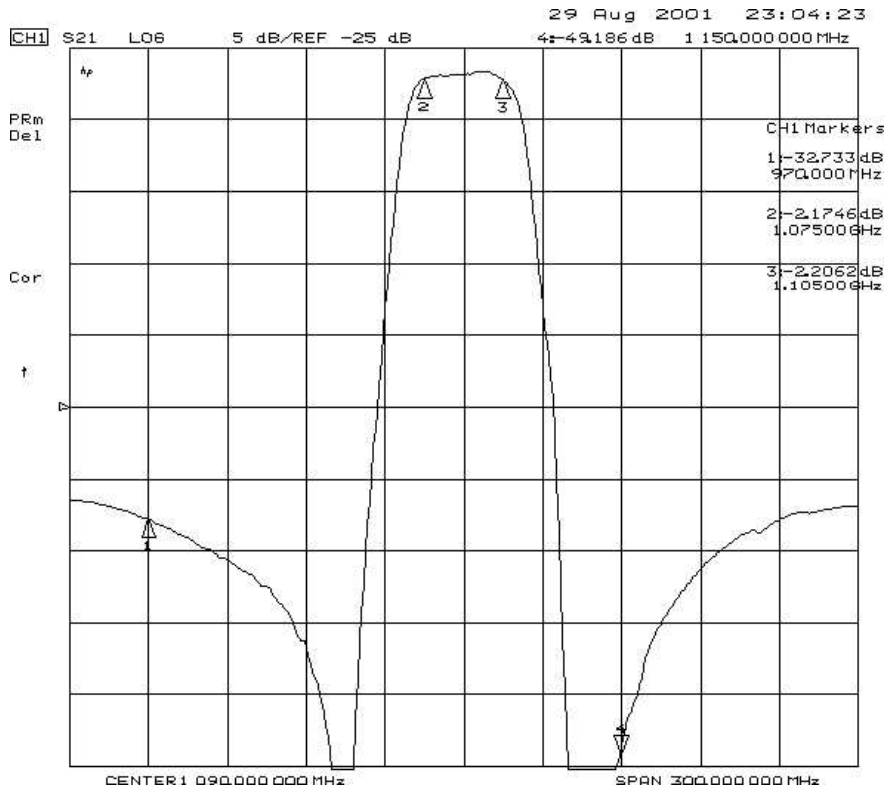

# Wideband

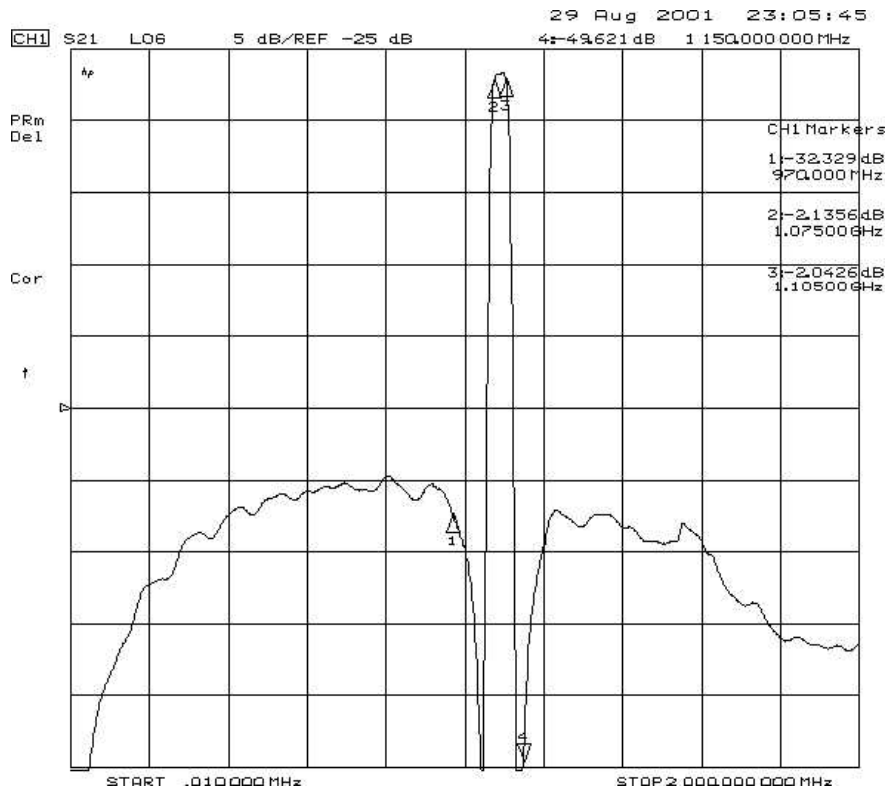

## Reflections Functions:

### Smith Chart

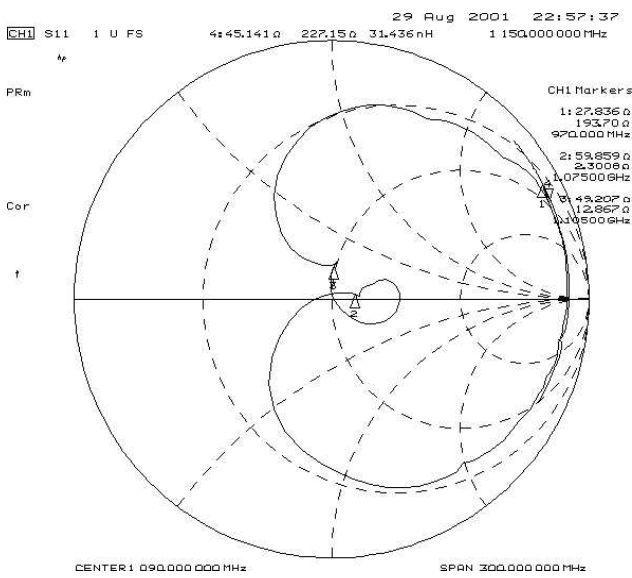

### VSWR

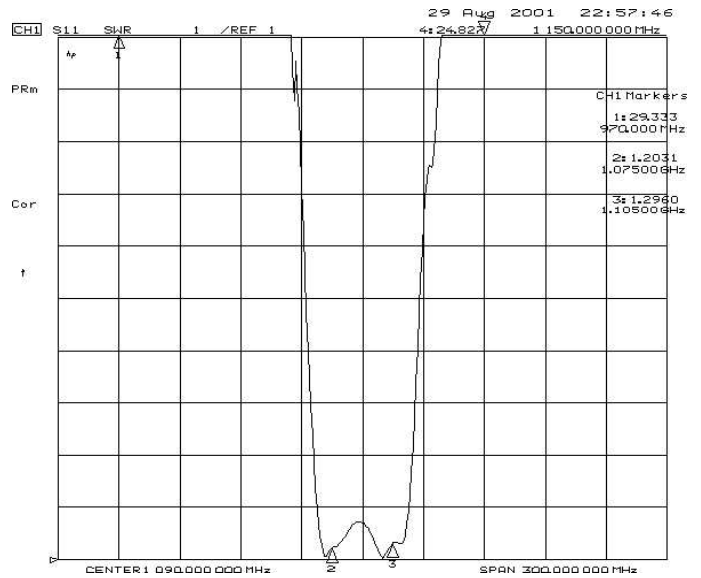

# SM3838-6 Case

## 6-Terminal Ceramic Surface-Mount Case

### 3.8 X 3.8 mm Nominal Footprint

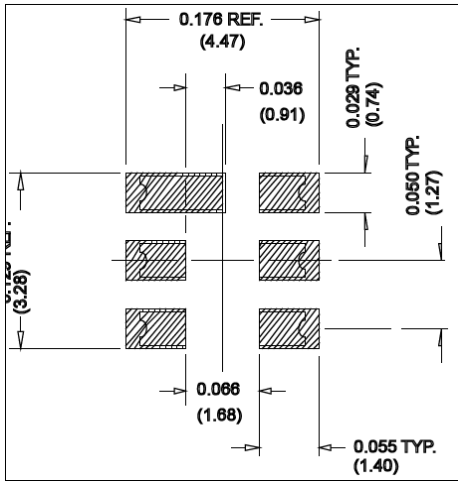
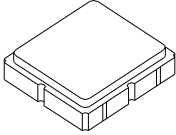

PCB Footprint

Dimension	Case Dimensions					
	mm			Inches		
	Min	Nom	Max	Min	Nom	Max
A	3.60	3.80	4.0	0.14	0.15	0.16
B	3.60	3.80	4.0	0.14	0.15	0.16
C	1.30	1.50	1.70	0.05	0.06	0.067
D	0.95	1.10	1.25	0.037	0.043	0.05
E	2.39	2.54	2.69	0.090	0.10	0.110
G	0.90	1.0	1.10	0.035	0.04	0.043
H	1.90	2.0	2.10	0.75	0.08	0.83
I	0.50	0.6	0.70	0.020	0.024	0.028
J	1.70	1.8	1.90	0.067	0.07	0.075

Electrical Connections		
Connection	Terminals	
Port 1	Single-ended Input	2
Port 2	Single-ended Output	5
	Ground	All others
Single-ended Operation Only		
Dot indicates Pin 1		

Materials	
Solder Pad Plating	0.3 to 1.0 $\mu\text{m}$ Gold over 1.27 to 8.89 $\mu\text{m}$ Nickel
Lid Plating	2.0 to 3.0 $\mu\text{m}$ Nickel
Body	$\text{Al}_2\text{O}_3$ Ceramic
Pb Free	

TOP VIEW

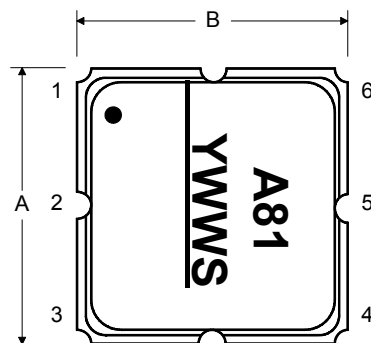

BOTTOM VIEW

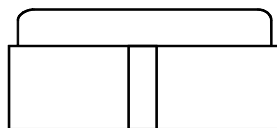
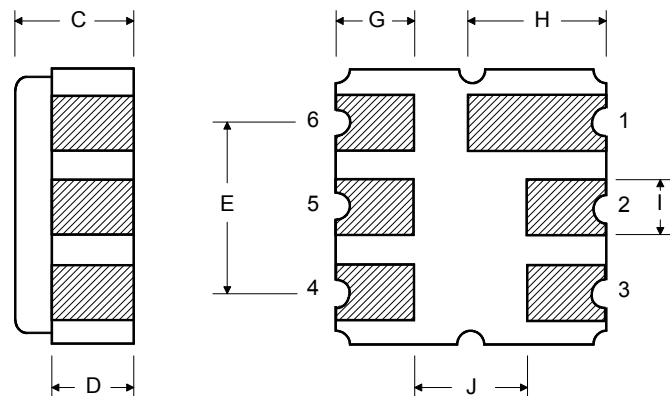

## Tape and Reel Specifications

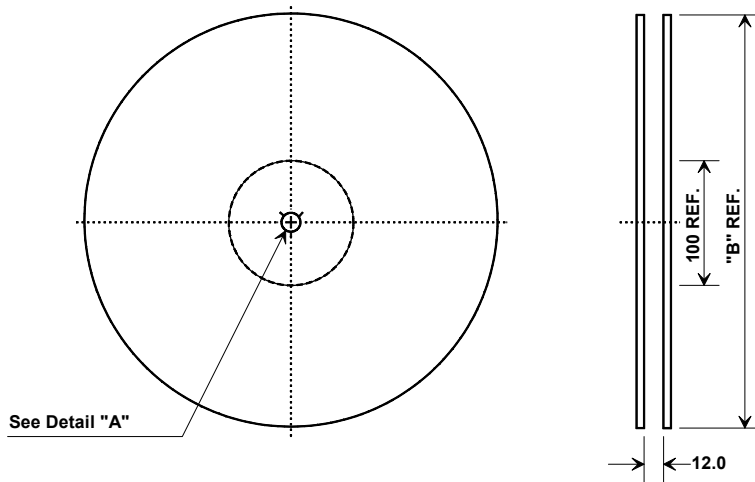

"B "		Quantity Per Reel
Inches	millimeters	
7	178	500
13	330	3000

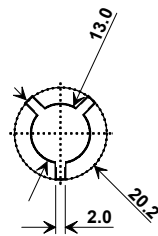

## COMPONENT ORIENTATION and DIMENSIONS

Carrier Tape Dimensions	
Ao	4.25 mm
Bo	4.25 mm
Ko	1.30 mm
Pitch	8.0 mm
W	12.0 mm

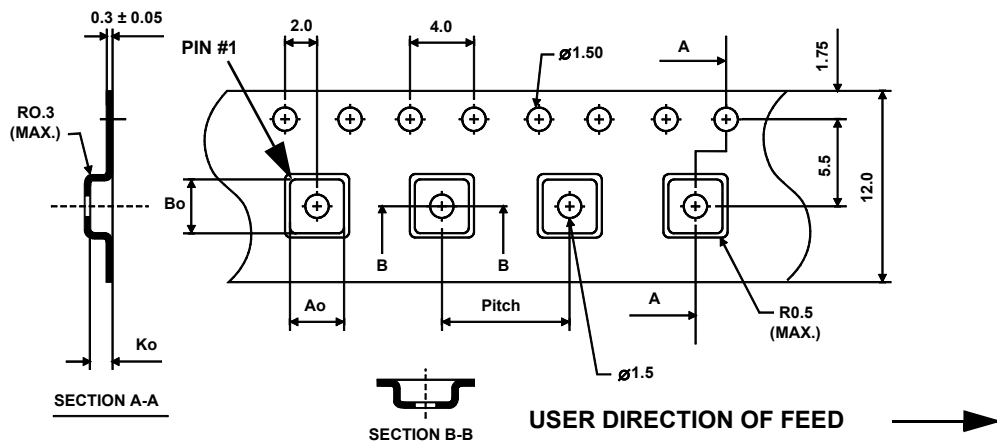

**Recommended Reflow Profile:**

